Comfort-Cire®

Century®

PARTS LIST

**Horizontal/Side Discharge
Condensing Units**

CMA1530SA

EXPLODED VIEW

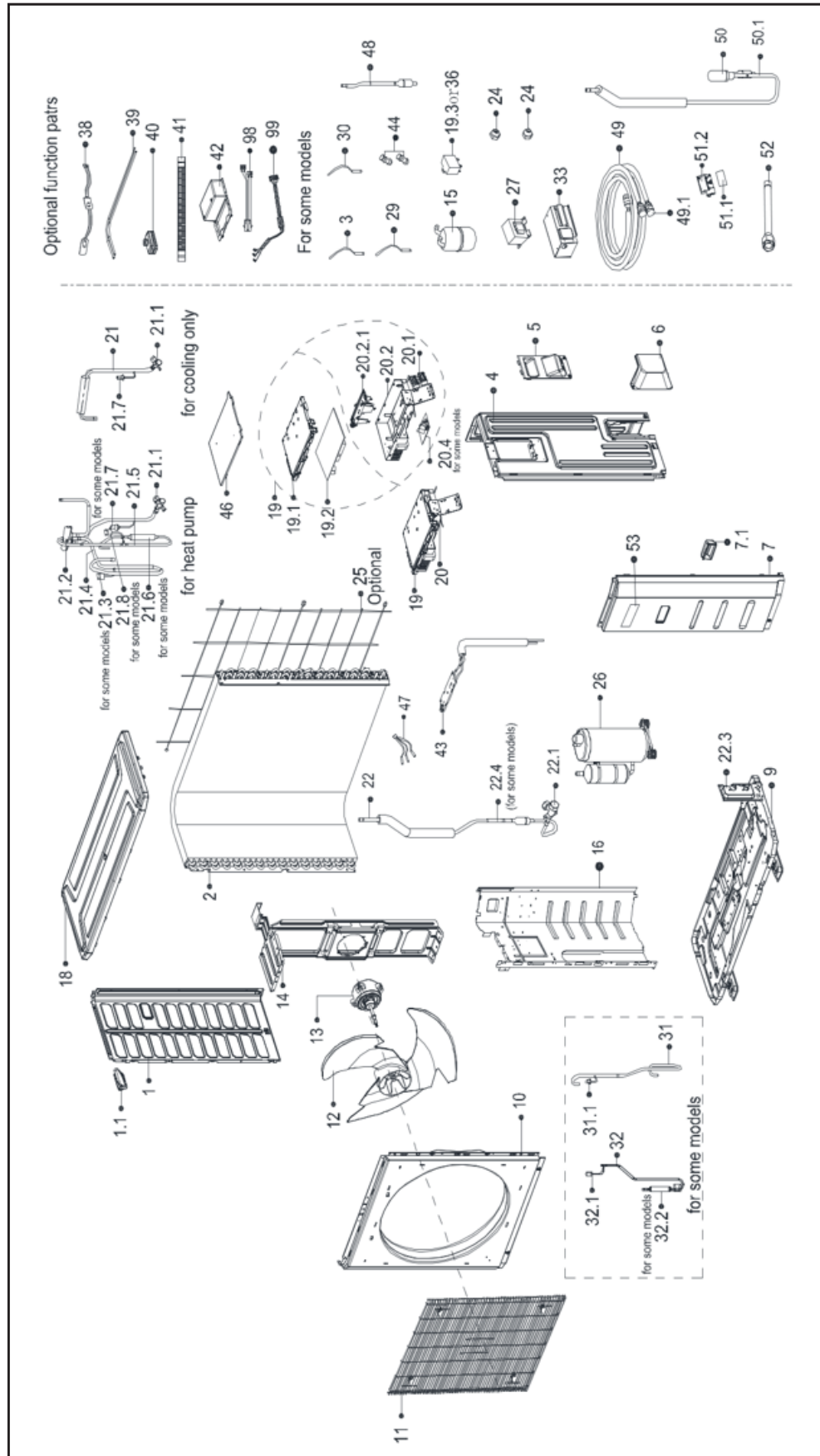

REPLACEMENT PARTS

Location	Part Name	Quantity	Part No.
1	Left side plate assembly of cabinet	1	12222000006665
1.1	Small handle	1	12100701000033
2	Condenser assembly	1	15822000014389
3	Pipe Temperature Sensor	1	11201007003445
3	Pipe Temperature Sensor	1	11201007000069
4	Rear Right Clapboard Assembly	1	12222000006664
5	Big handle assembly	1	12222000013365
6	Water Collector	1	12122200002695
7	Front Right Clapboard Assembly	1	12222500A00135
7.1	Handle	1	12100702000038
9	Chassis assembly	1	12222000004018
10	Front panel	1	12222000A01431
11	Air outlet grille	1	12222000014845
12	Axial Flow Fan	1	12100105000084
13	Brushless DC Motor	1	11002015000247
14	Motor Bracket Assembly	1	12222000005162
15	Accumulator cylinder	1	15500508000315
16	Partition Board Assembly	1	12222000012328
18	Top Cover Assembly	1	12222500000587
19	Electronic control box subassembly	1	17222000041447
19.1	Cover of electronic control box	1	12122000025662
19.2	Outdoor main control board subassembly	1	17122000059854
20	Terminal board subassembly	1	17222000041446
20.1	Terminal	1	17400401000119
20.2	Electronic installing box subassembly	1	12222000015265
20.2.1	U-Typed Support with Copper Pipe	1	12122000024381
20.4	Inverter module subassembly	1	17122000062607
21	Gas valve assembly	1	15422000024016
21.1	Gas Valve	1	15500204000482
21.4	Suction pipe	1	15122000032520
21.7	Pressure sensor	1	11201008000773
22	Liquid valve assembly	1	15422000024035
22.1	Gas Valve	1	15500204000021
22.3	Valve Plate	1	12222200000611
24	Flare Nut	1	15500406000010
24	Copper nut	1	15500406000008
25	Rear net	1	12222000006604
26	DC Inverter Rotary Compressor	1	11103020000559
31	Suction pipe assembly	1	15122000029898
31.1	Pressure Controller	1	17400516000848
32	Discharge pipe assembly	1	15122000032537
32.1	Pressure Controller	1	17400516000851
32.2	Muffler	1	15500506000007
38	Crankcase electric heater	1	17402001000601
43	Radiator subassembly	1	15122000028848
46	Cover of electronic control box	1	12122000016029
47	Combination Sensor	1	11201011000188
52	Evaporator connecting pipe subassembly	1	15123000012948
52	Evaporator connecting pipe subassembly	1	15123000012887
53	Trademark	1	16000201001228
99	Compressor Wires Subassembly	1	17401203000751

Due to ongoing product improvements, specifications and dimensions are subject to change and correction without notice or incurring obligations. Determining the application and suitability for use of any product is the responsibility of the installer. Additionally, the installer is responsible for verifying dimensional data on the actual product prior to beginning any installation preparations.

Incentive and rebate programs have precise requirements as to product performance and certification. All products meet applicable regulations in effect on date of manufacture; however, certifications are not necessarily granted for the life of a product. Therefore, it is the responsibility of the applicant to determine whether a specific model qualifies for these incentive/rebate programs.

Comfort-Aire® **Century**®

1900 Wellworth Ave., Jackson, MI 49203 • Ph. 517-787-2100 • www.marsdelivers.com

